



7

NOVEMBER
2022

SEMIC Webinar

DIGIT.D2 - Interoperability.

interoperable
europe

Objectives of this 2nd webinar



Discuss latest issues on CPSV-AP



Presenting work done on Controlled Vocabularies

Agenda

1

Welcome

2

Context of the Core Vocabularies

3

Issues on CPSV-AP - Part 1

4

Short break

5

**Issues on CPSV-AP - Part 2
and Controlled Vocabularies**

6

Wrap up and next steps

Workshop practicalities



Click on 'connect audio' but please mute your microphones



You can also share your questions for the Q&A session via the chat



The workshop will be recorded



Context of the Core Vocabularies

Introduction to SEMIC

The objectives of the SEMIC action is to promote Semantic Interoperability amongst the EU Member States by:

- Promotion, sharing and reuse of semantic assets, experience and tools and facilitating agreements in key areas.
- Identifying opportunities for alignment on semantic definitions, metadata and reference data sources with special focus on identification and definitions of Core Concepts / Vocabularies.
- Raising awareness on the importance of data and metadata management.



Objectives of the Core Vocabularies

The e-Government Core Vocabularies are

- **simplified,**
- **re-usable,** and
- **extensible**

data models that capture the **fundamental** characteristics of a data entity in a context-neutral and syntax-neutral fashion.

Current SEMIC assets

CORE
PERSON
VOCABULARY

A person's name(s), date and place of birth/death, identifier, addresses, citizenship, etc.

CORE
BUSINESS
VOCABULARY

The legal name, address, identifier, company type, and activities of a legal entity.

CORE
LOCATION
VOCABULARY

The different ways of describing a location, e.g. via an address, a geographic name, or a geometry, in alignment with INSPIRE.

CORE
PUBLIC
ORGANISATION
VOCABULARY

The administrative information, hierarchy, identifiers, events and classification of a public organisation.

CORE
CRITERION &
EVIDENCE
VOCABULARY

The requirements and evidence of a procedure or formal process.

Vocabularies

Application Profiles

CORE
PUBLIC
SERVICE
VOCABULARY
Application Profile

DCAT-AP
FOR
DATA PORTALS
IN EUROPE

GeoDCAT-AP
FOR
GEOSPATIAL
DATASETS

StatDCAT-AP
FOR
STATISTICAL
DATASETS

ADMS
ASSET
DESCRIPTION
METADATA
SCHEMA

Timeline webinars



Recap:

- Core Location: issues on Address and AdminUnit
- CPOV: issues on ContactPoint with replacement of OpeningHoursSpecification by TemporalEntity
- Core Public Event: main classes including Participation and TemporalEnti

Migration of CPSV-AP and BregDCAT-AP

As of 1st October [CPSV-AP](#) and [BregDCAT-AP](#) are under the SEMIC GitHub organisation repository, for better management of the SEMIC assets.

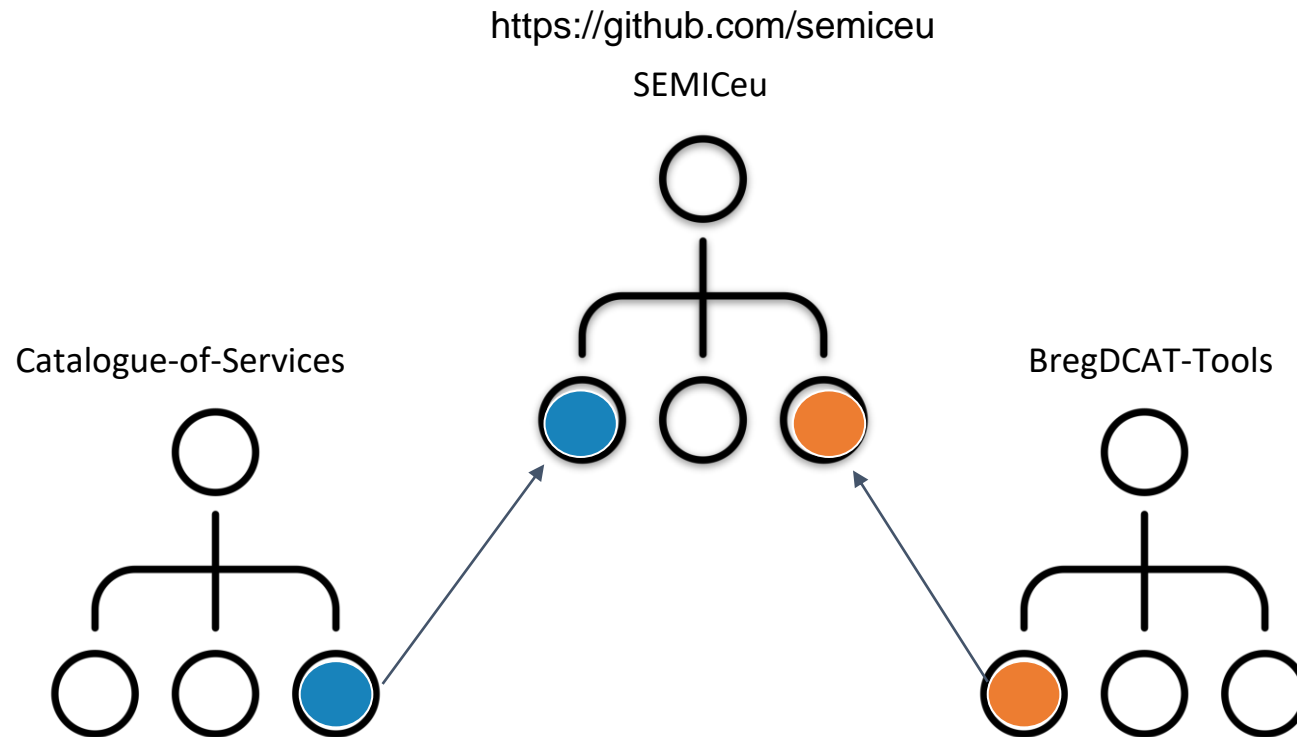



Issues on CPSV-AP - Part 1

CPSV-AP 3.0.0

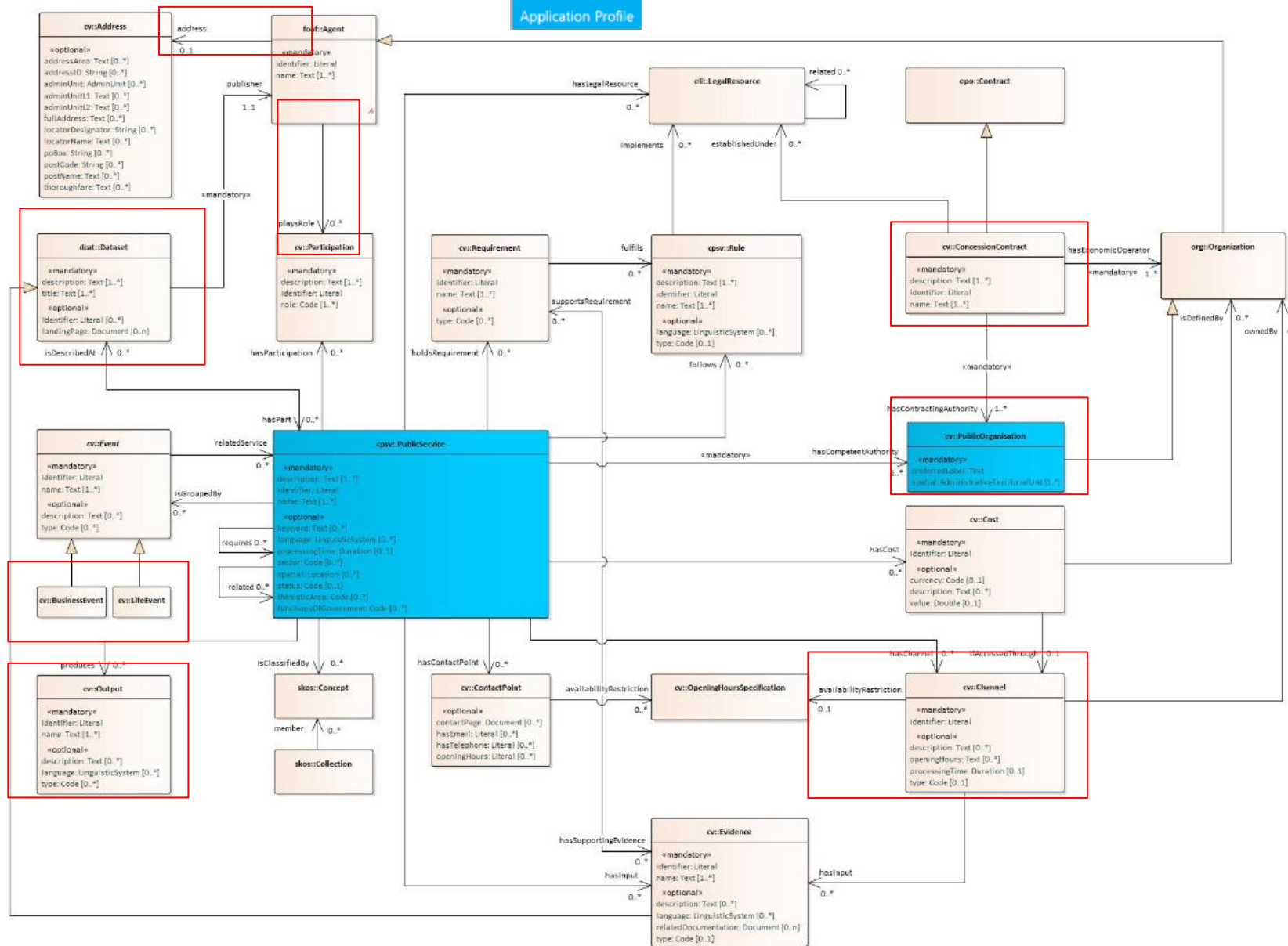

locn:address in the class foaf:Agent: the cardinality should be 0..* (issue [#107](#))

Request:

The cardinality for the property address (locn:address) in the class Agent (foaf:Agent) currently is 0..1.

It should be 0..*, because an Agent may have several different addresses.

The Norwegian Labour and Welfare Administration, the Norwegian Tax Administration etc., all have their local offices in different cities, and several local offices in the same city, thus many different visiting addresses.

Proposition:

Relax the cardinality of relation Agent - Address (0..*)

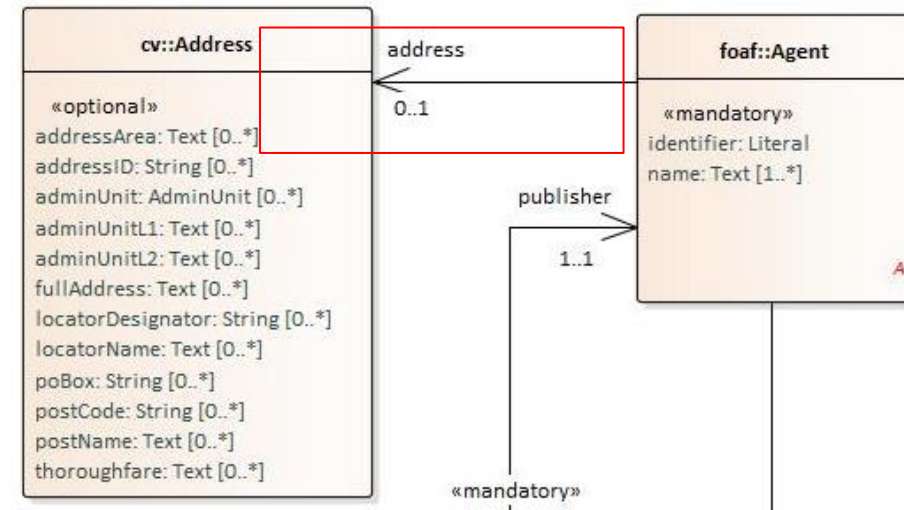

Public Organization - preferred label: should be 1..* (issue [#99](#))

Request:

The property preferred label in the class Public Organization currently is 1..1. It should be 1..*, to allow different preferred names in different languages, e.g. "European Commission" in all the European languages.

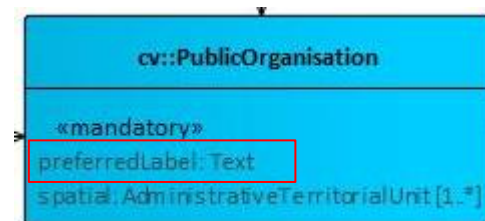

Proposition:

Relax cardinality like other classes with name/title and description.

In SKOS "A resource has no more than one value of skos:prefLabel per language tag".

Examples will be added in the usage note.

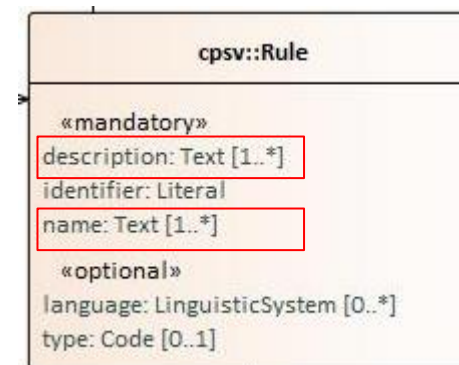
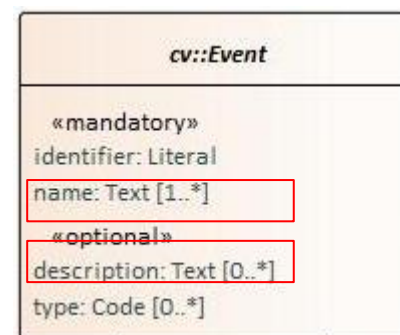
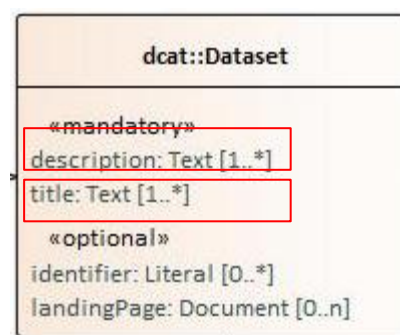
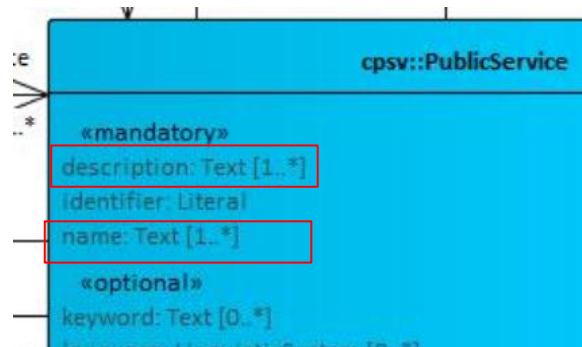

Definition of the class Dataset is unclear (issue [#103](#))

Request:

Change current definition of Dataset:

“This class represents a collection of metadata and where they can be found, for instance on a regional public service portal and/or a national eGovernment portal.”

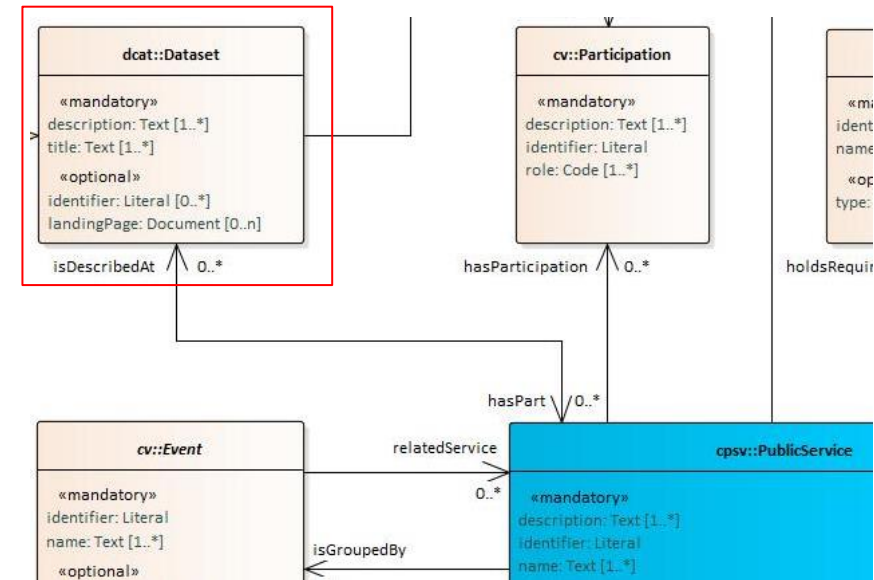

.Proposition:

- Reuse definition from DCAT: "A collection of data, published or curated by a single agent, and available for access or download in one or more representations."
- Add in the usage note the current definition.

Why 0..n for dct:identifier in Dataset (while it is 1 for all other dct:identifier)? (issue [#84](#))

Request:

The identifier in Dataset has cardinality 0..* while in other classes the identifier has cardinality 1..1.

Proposition:

- Keep the cardinality open (0..*)
- Add the [guideline on identifiers](#) in the usage for further information on how to use identifiers in the context of Datasets

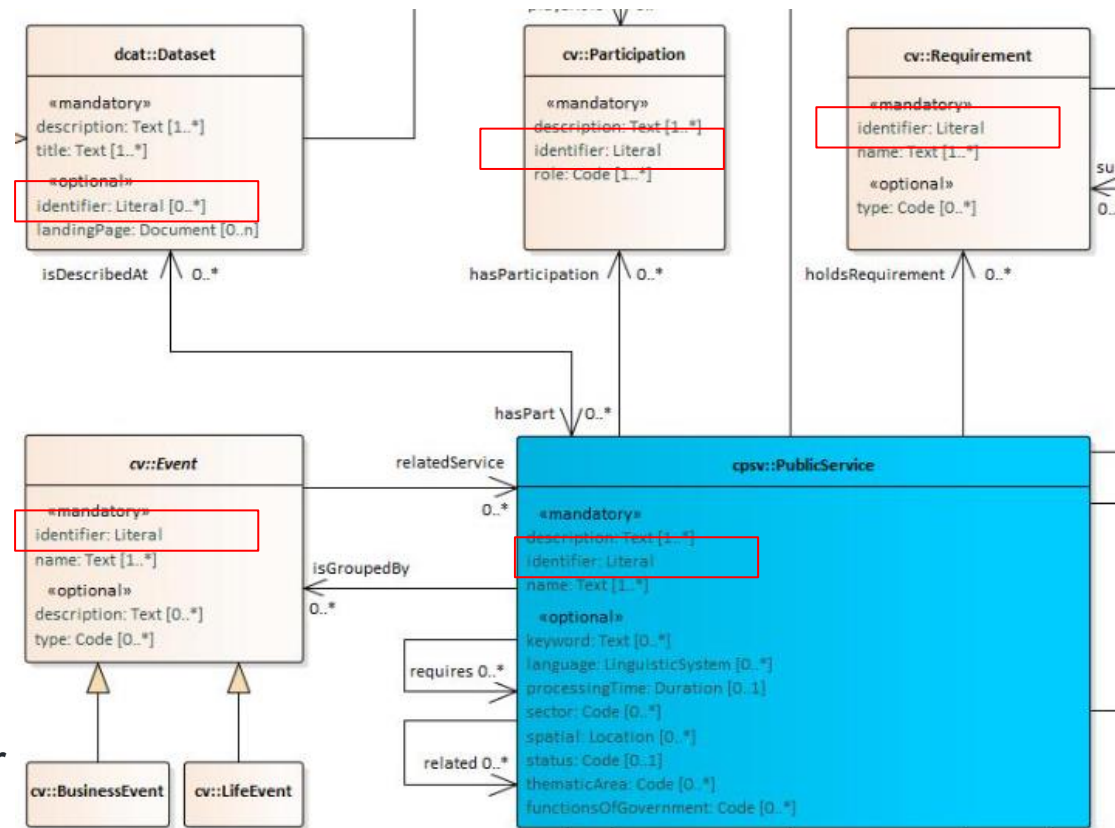

cv:Output as a subclass of dcat:Dataset? (issue [#91](#))

Request:

Like the Evidence class, make Output class a subclass of Dataset.

Evidence definition:

Evidence can be any resource - document, artefact - anything needed for executing the Public Service. In the context of Public Services, Evidence is usually administrative documents or completed application form.

Output definition:

An output can be any resource - document, artefact - anything produced by the Public Service. In the context of a Public Service, the output provides an official document or other artefact of the Competent Authority (Public Organization) that permits/authorises/entitles an Agent to (do) something.

Question:

- What are the needs ? Reusing dataset properties ?

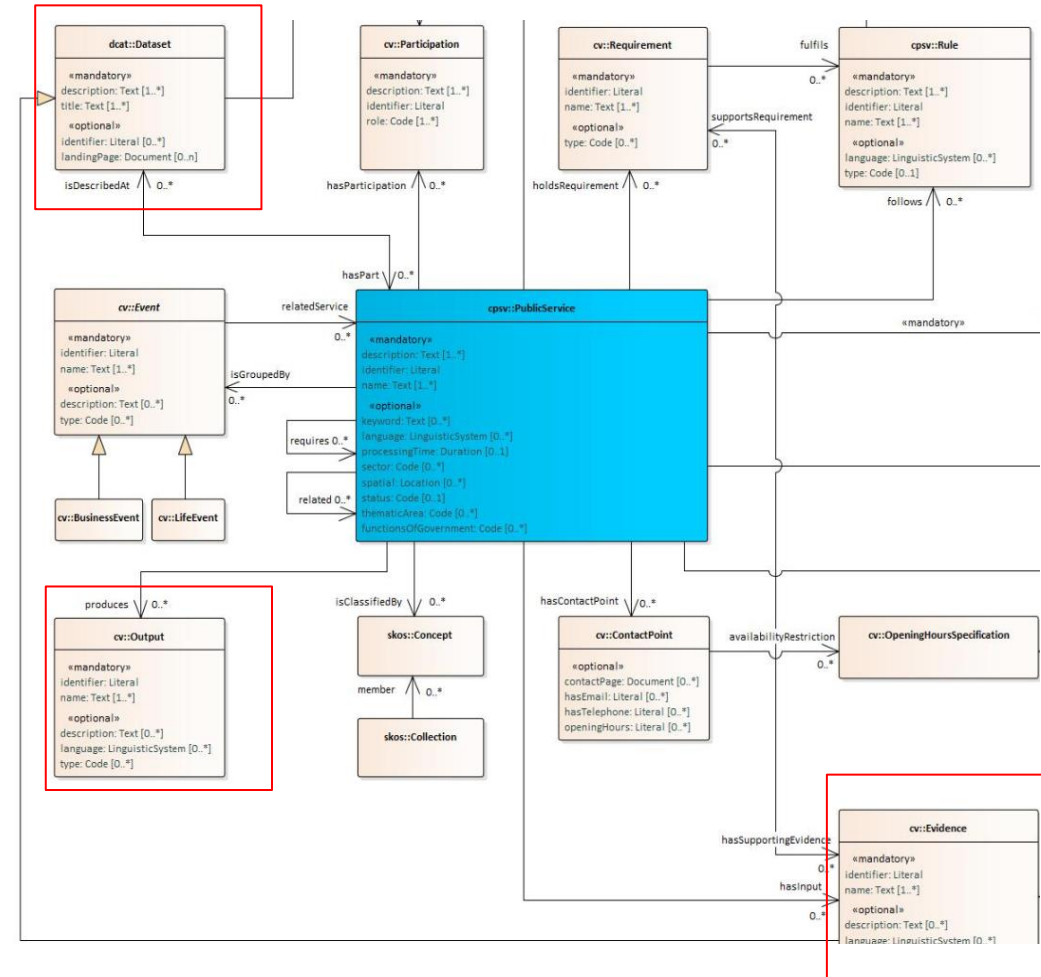

How to specify the "address" of a channel? (issue [#66](#))

Request:

How to specify the e-mail address when the channel type is `e-mail`, the homepage/URL when the channel type is `homepage`, etc.?

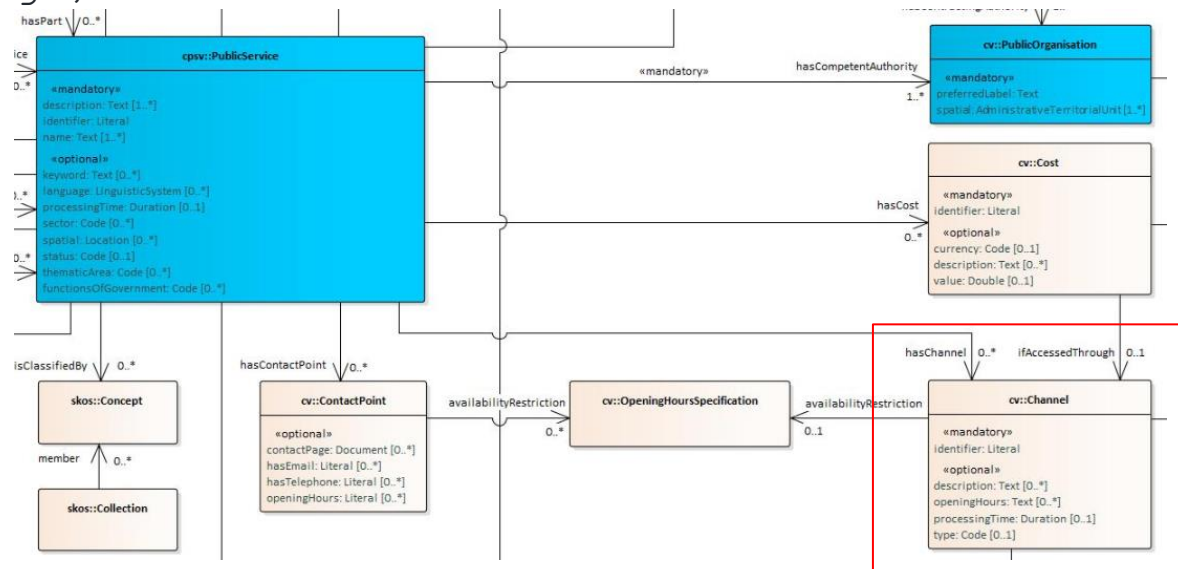

Proposition:

MS can extend the Channel class to add properties/subclass.
Which channels are often used by MS?

Alignment with CPOV: Specifying normal opening hours as structured data in Channel and Contact point (issue [#86](#))

CPOV

Request:

Like for Contact Point, make Channel have a relationship towards Temporal Entity for normal opening hours.

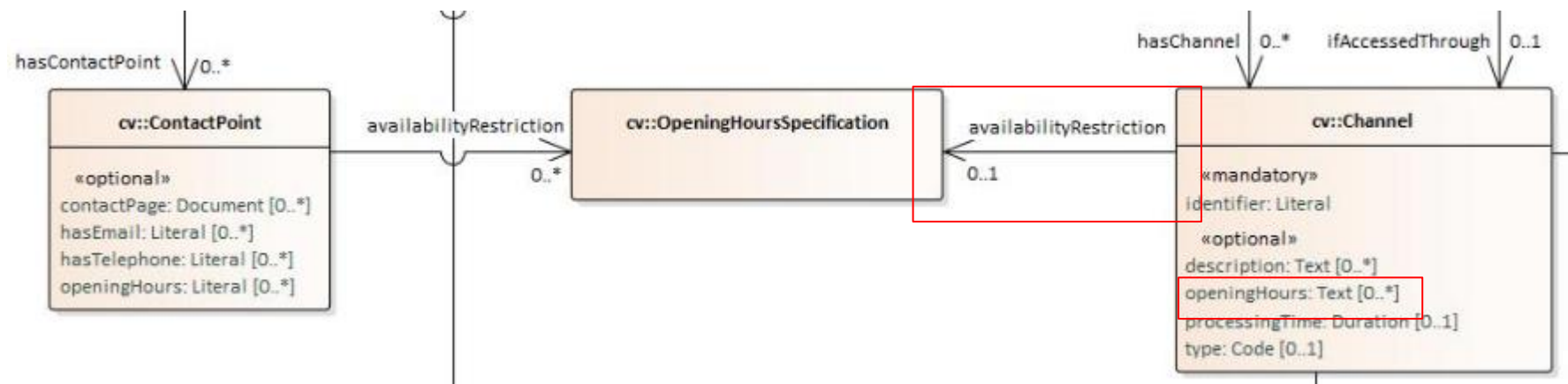
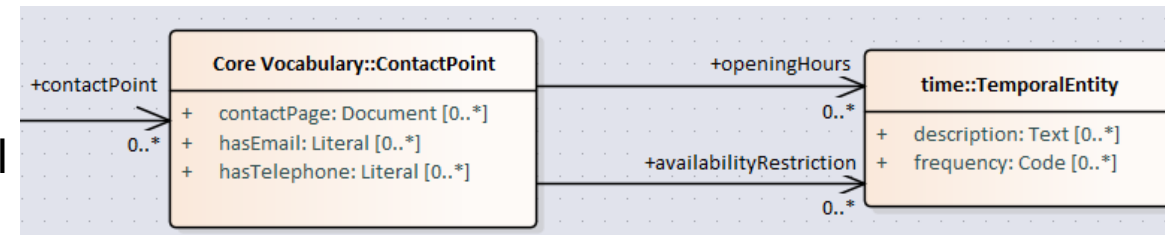

Proposition:

Add same relations (openingHours and availabilityRestriction) to Channel like for ContactPoint towards TemporalEntity.



Short break (5 minutes)



Issues on CPSV-AP - Part 2

Use of cccev:EvidenceType instead of cv:Evidence (issue [#95](#))

Request:

Add direct relation between Public Service and EvidenceType in case of public service description

For example:

- For the case of Public Service descriptions it needs to describe the generic type e.g. any id card (EvidenceType)
- For the case of Public Service execution it needs to describe the instances e.g. ID card of John Doe (Evidence)

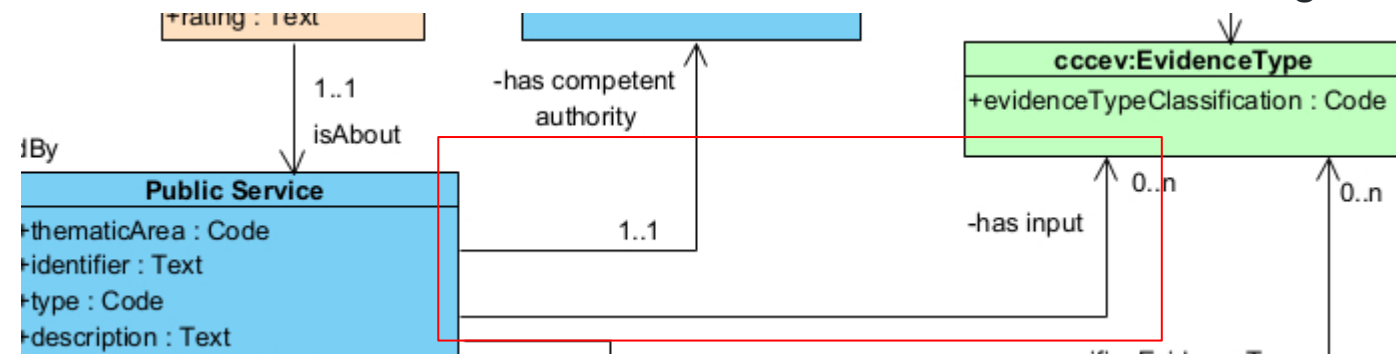

Proposition:

Add relation “hasEvidenceType” between Public Service and EvidenceType to support public service descriptions case.

Inverse relation between Participation and Agent (issue [#110](#))

Request:

Add inverse relation between Participation and Agent.

Proposition:

In alignment with the request during the Core Public Event webinar, add the inverse relation "hasParticipant".

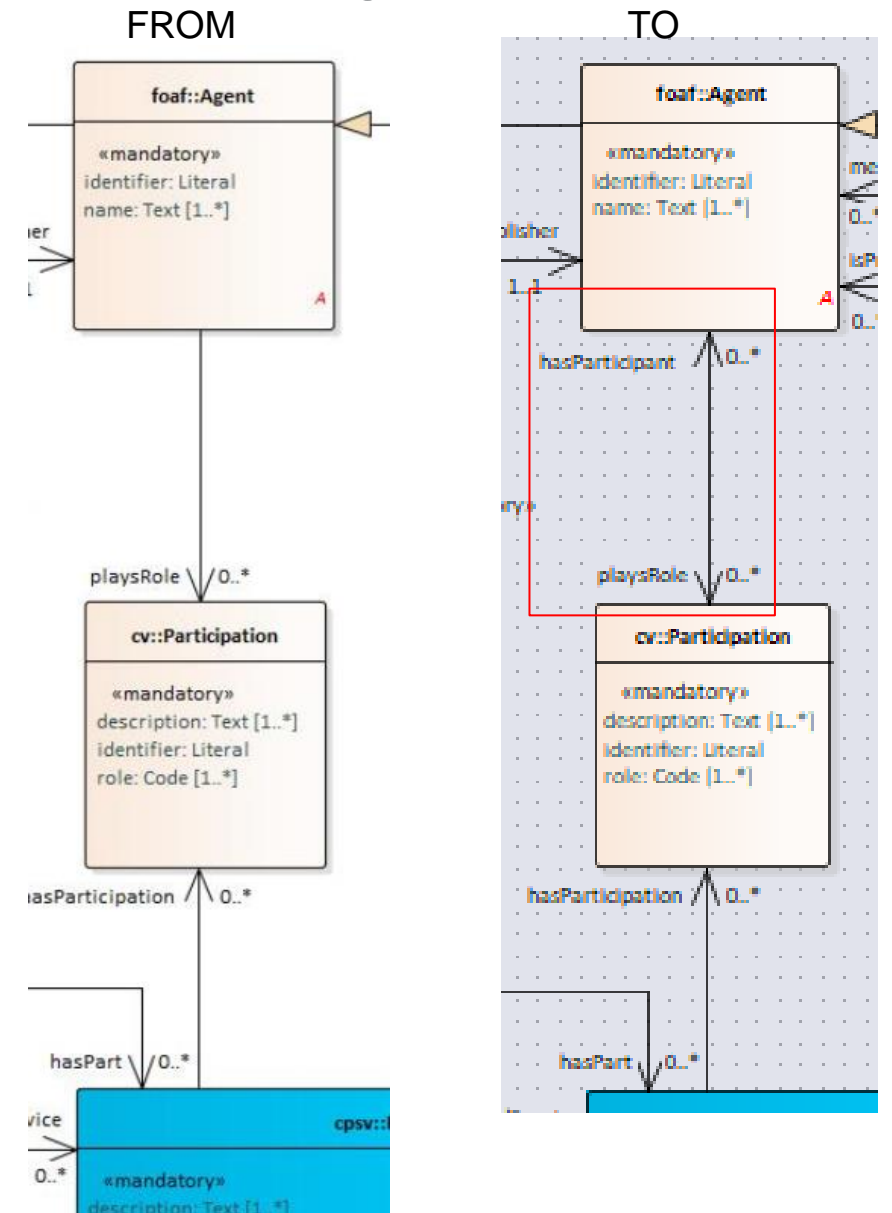

Add explicitly the Public Service Consumer (issue [#96](#))

Request:

Make an explicit relation between Public Service and Agent.

Proposition:

Add relation **“isProvidedTo”** since it could be helpful for public service execution to analyse usage of Public Service.

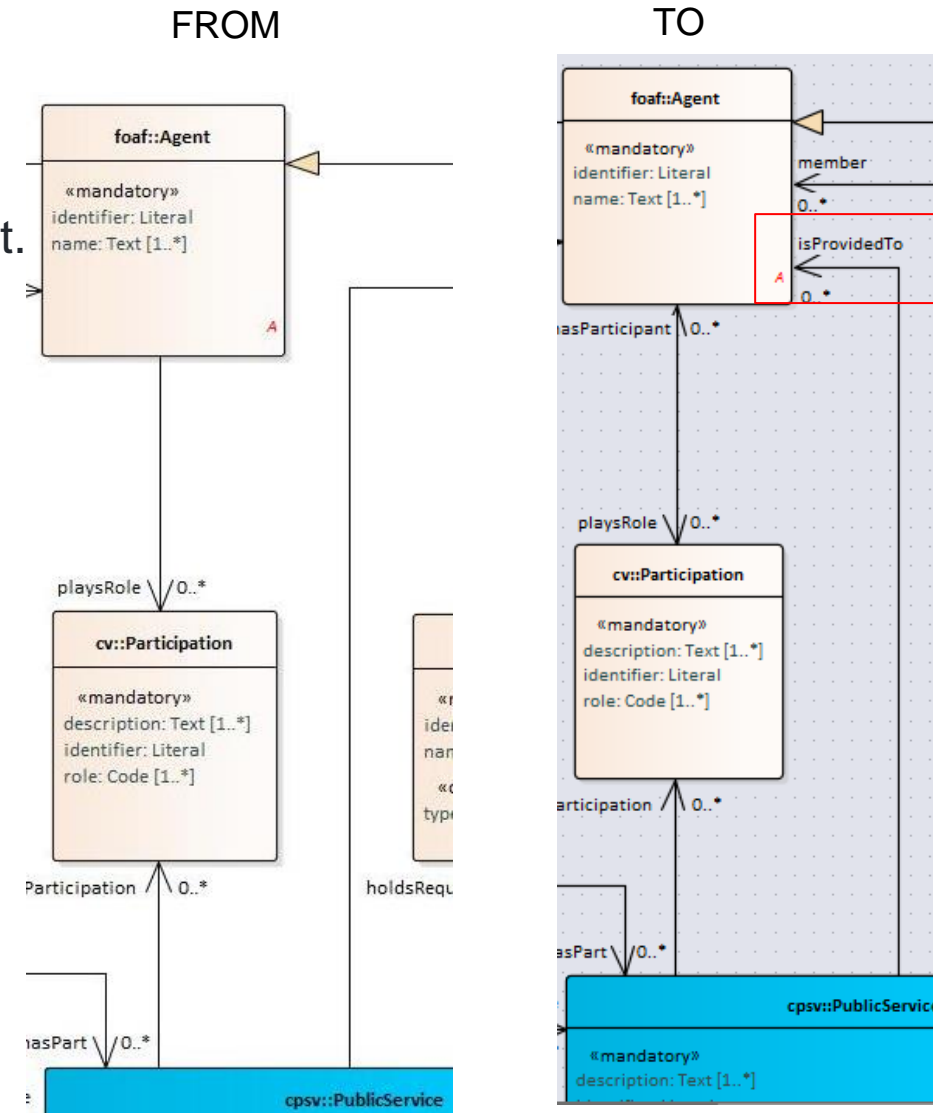

Addressee and SDG Annexes (issue [#79](#))

Request:

Add a category of addressee to which a Public Service is addressed to, such as citizens, businesses, etc.

Proposition options:

- 1) Add property "addressee" (code) to Public Service to indicate the addressee of a Public Service
- 2) Add relation "addressee" to a foaf:Group to which an Agent might belong to.

Option 1

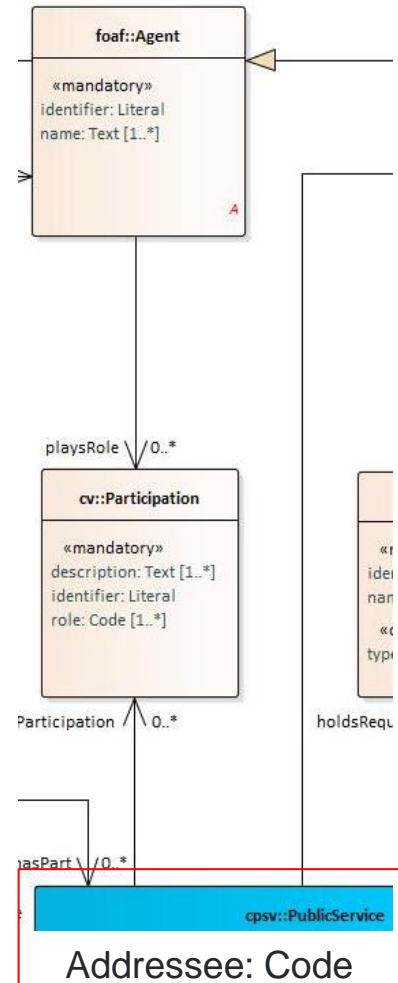

Option 2

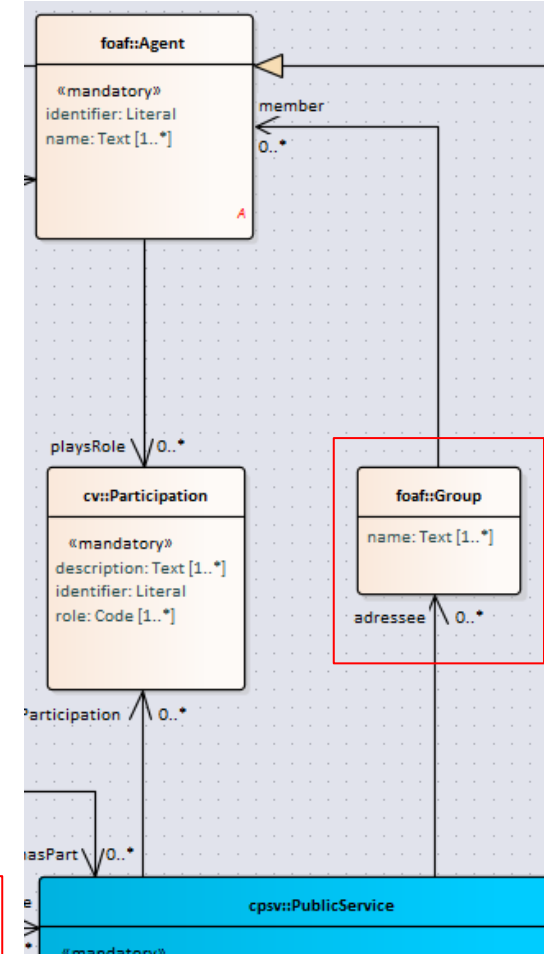

Concession Contract: Eprocurement ontology (issue [#100](#))

Request:

Since the 3.0.0 release of the Eprocurement Ontology has introduced the Concession Contract, which is already present in CPSV-AP.

Definition in EPO: “A contract between one or more buyers and one or more economic operators giving the right to the economic operators to exploit the rights foreseen in the contract which may include the receipt of payments.”

Definition in CPSV-AP: “Concessions are contracts for pecuniary interest by means of which one or more contracting authorities or contracting entities entrusts the execution of works, **or the provision and the management of services**, to one or more economic operators.”

From Directive [2014/23/EU](#) (paragraph 11)

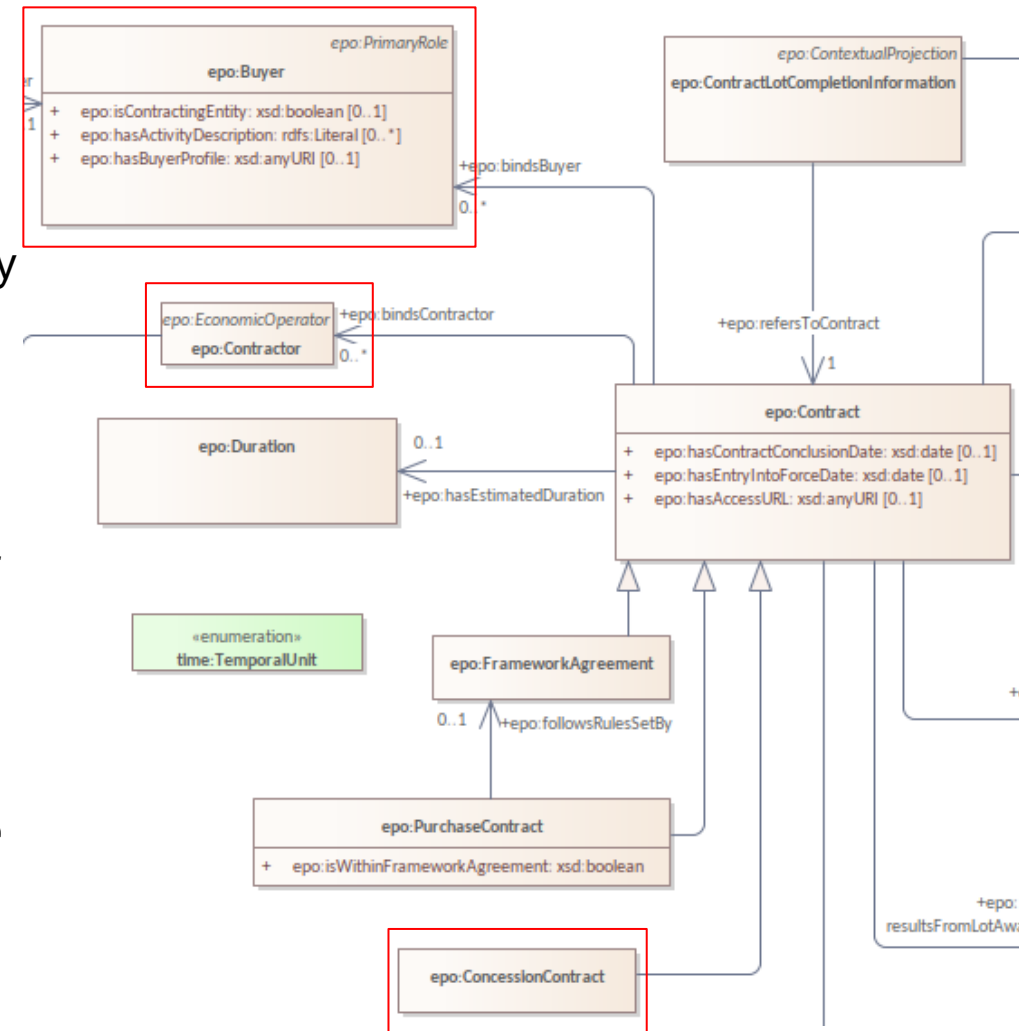

Concession Contract: Eprocurement ontology

(issue [#100](#))

Proposition:

Keep URI as the definition comes from the Directive and mention services.

- Optional: create a relation between the 2 URIs

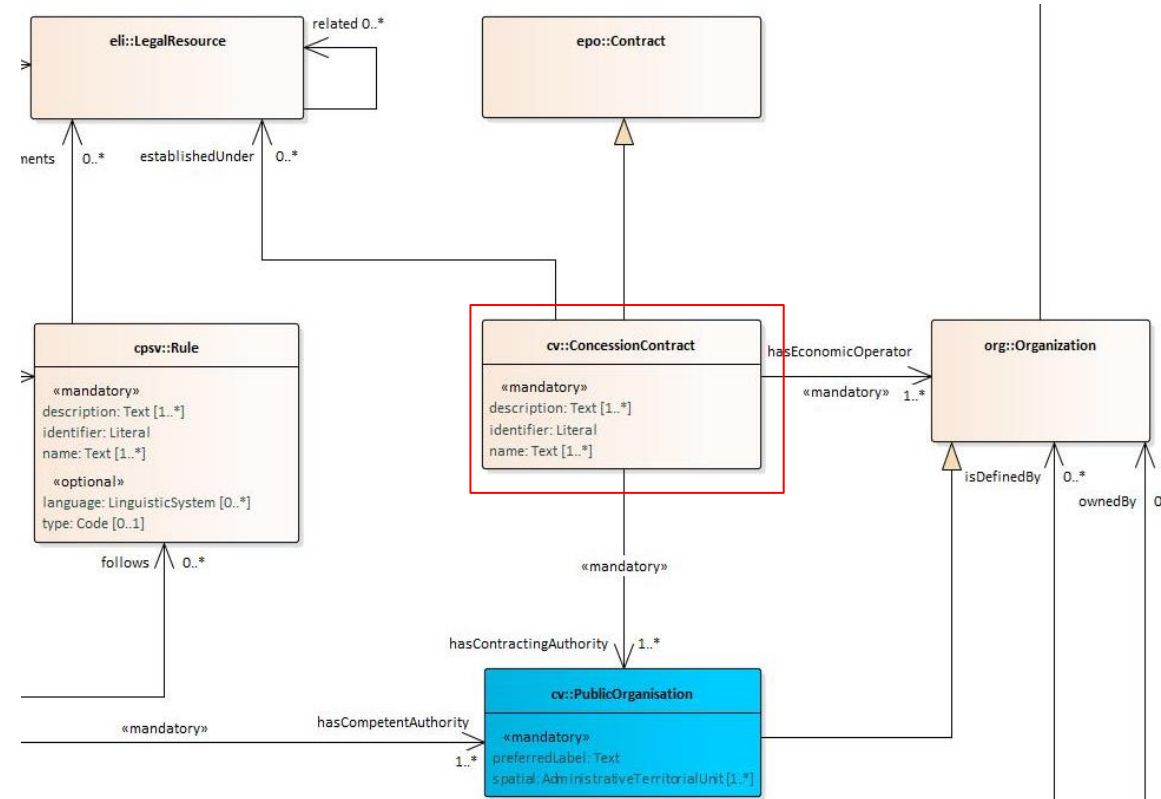

dct:relation has multiple ranges in the rdf schema (issue [#63](#))

Request:

dct:Relation is used 3 times:

1. from event to public service (range: public service)
2. from public service to itself (range: public service)
3. from legal resource to itself (range: legal resource)

As a consequence in the rdf schema, it appears that dct:relation has public service and legal resource as ranges

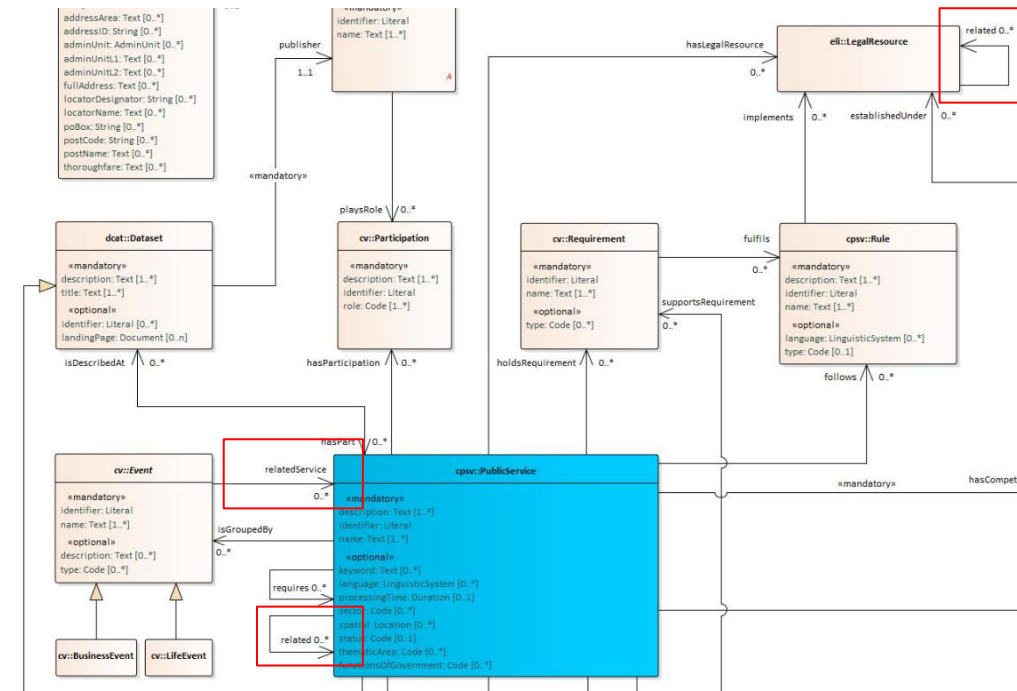

Proposition:

Make the relations as subproperties of dct:relation

- data.europa.eu/m8g/relatedService (from Event/Public Service to Public Service)
- data.europa.eu/m8g/relatedLegalResource (from Legal Resource to itself)

Communication: Updates on the model (issues [#101](#), [#104](#) and [#105](#))

FROM:

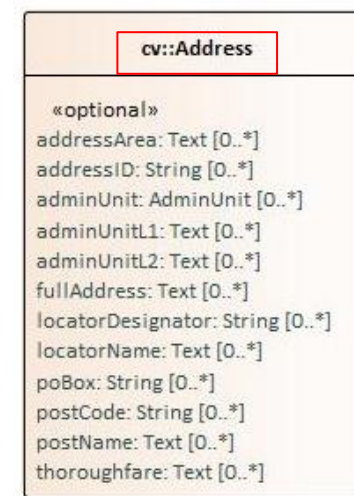
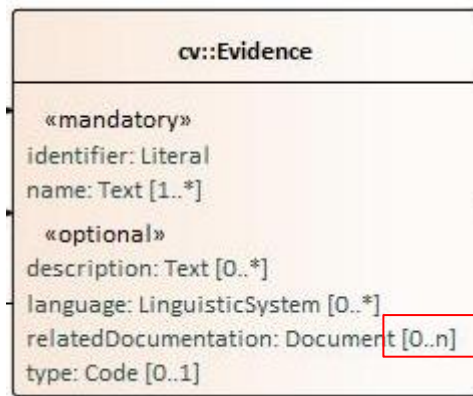
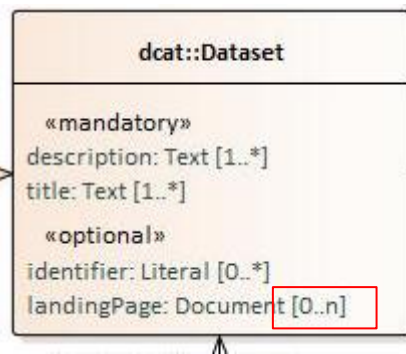

Typo

<http://data.europa.eu/m8g/hasEmail>
<http://data.europa.eu/m8g/hasTelephone>

TO:

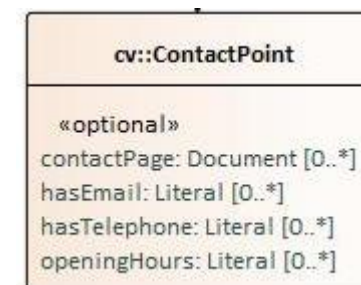
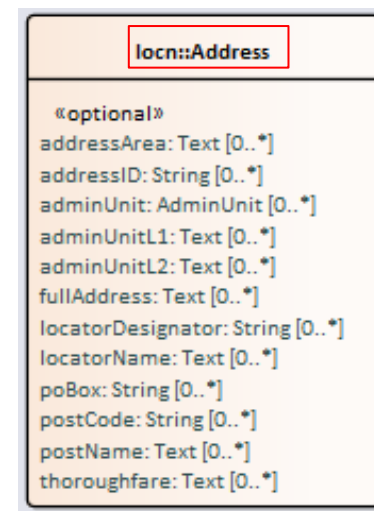
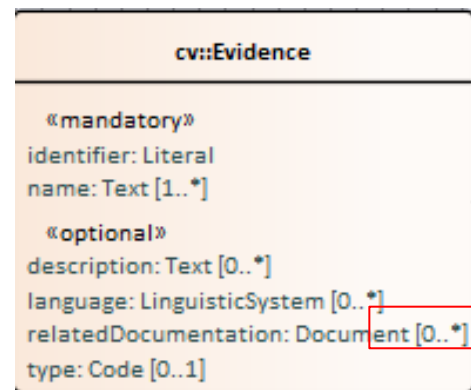
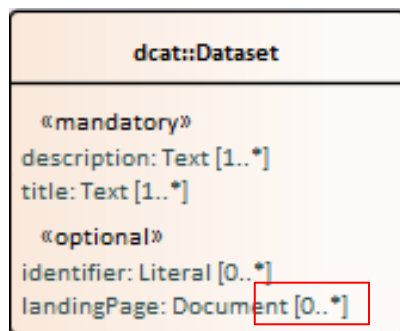

<http://data.europa.eu/m8g/email>
<http://data.europa.eu/m8g/telephone>



Controlled Vocabularies

Business and Life events (issues [#50](#), [#74](#) and [#76](#))

Needs:

- Grouping public services by event (#76)
- Provide machine readable description (#74)
- Taking in account 21 procedures listed in [Annex II of SDGR](#) (#50)

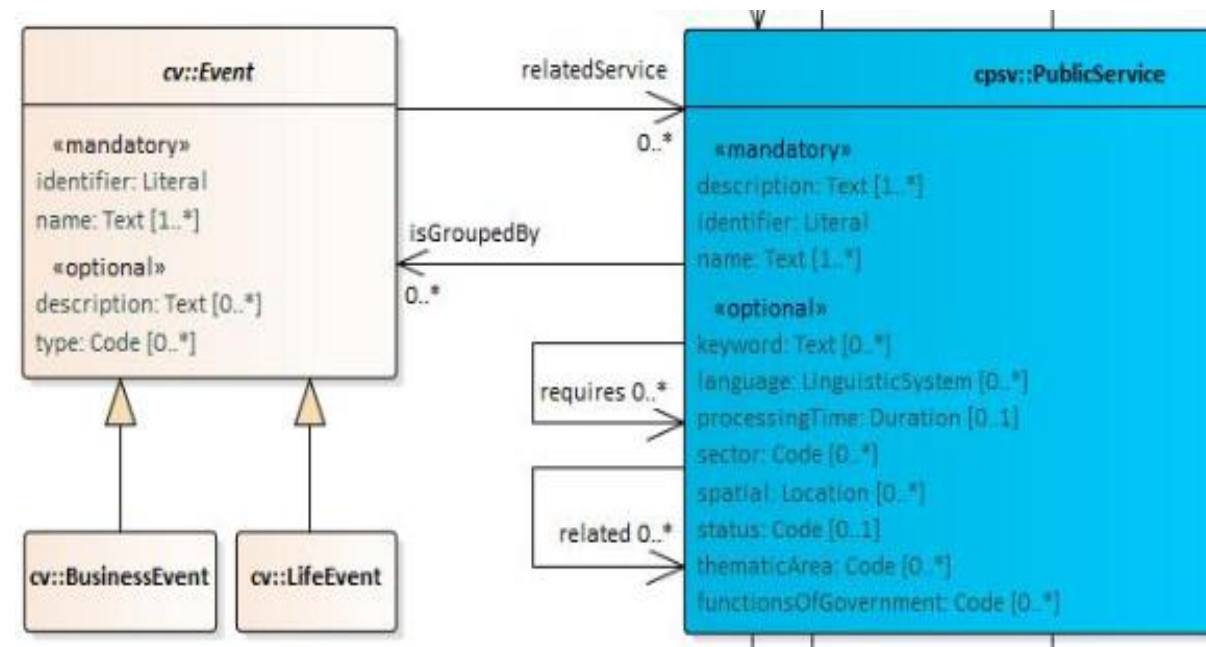

Proposed classification for Business and Life events

Feedback / comments	Proposed controlled vocabulary: Life Events		Annex IV: Description of 1st level life events		Annex II: SDGR	
	Lvl 1 Life events 2.0	Description	1st level life event	Description	Life events	Procedures
	Birth	This life event groups public services related to being or becoming a	Having a child	This life event groups public services related to becoming a caretaker for a child, for instance in case of giving birth, adopting, receiving a foster child...	Birth	Requesting proof of registration of birth
	Becoming a (social) ca	This life event groups public services related to the situation where you	Becoming a (social) caretaker	This life event groups public services related to the situation where you need to take care of another person (other than when you get a child), for instance for an elder, a disabled		
	Going into military serv	This life event groups public services related to taking up a mandatory	Going into military service	This life event groups public services related to taking up a mandatory military or civil service.		
	Retiring	This life event groups public services related to when someone retires	Retirement	This life event groups public services related to when someone retires from his job or becomes a senior.	Retiring	Claiming pension and pre-retirement benefits from compulsory schemes
					Retiring	Requesting information on the data related to pension from compulsory schemes
	Studying	This life event groups any public service related to education,	Starting education	This life event groups any public service related to education, for example pre school education, elementary school,	Studying	Submitting an initial application for admission to public tertiary education institution
					Studying	Applying for a tertiary education study financing, such as study grants and loans from a public body or institution
					Studying	Requesting academic recognition of diplomas, certificates or other proof of studies or courses
	Working	This life event groups public services related to working, for example when	Looking for a new job	This life event groups public services for when someone looks for a new job or starts a new job		

Link: <https://github.com/SEMICeu/Taxonomy#business-and-life-event-taxonomy-file>



Wrap-up and next steps

Timeline webinars

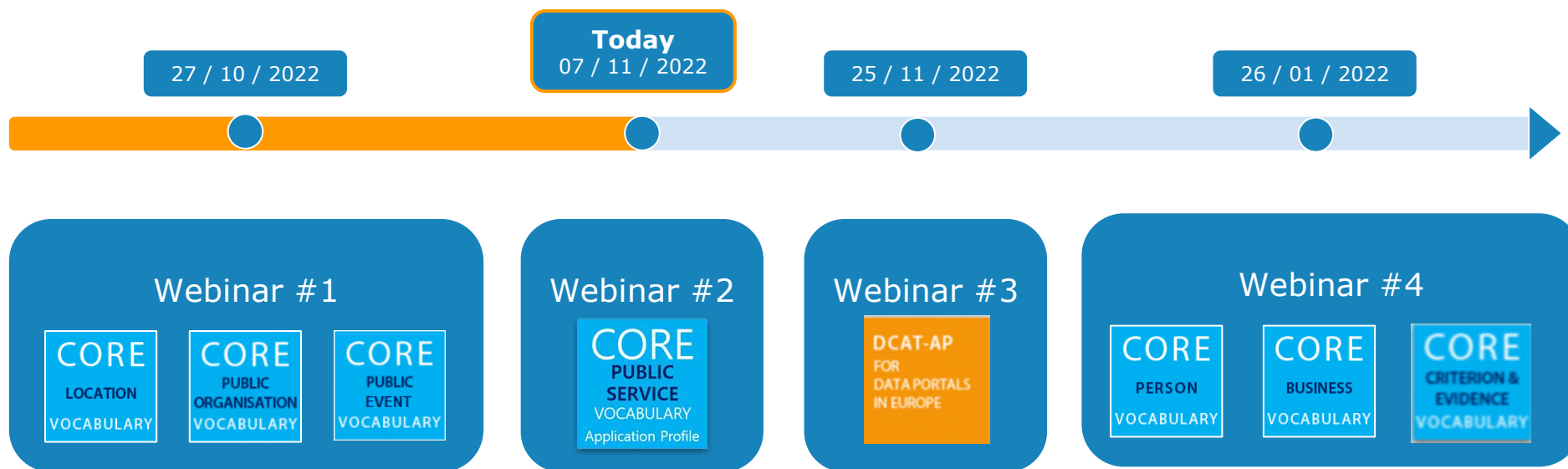

Next steps



Stay tuned for the next webinar on DCAT-AP



In the meantime, you are invited to share your feedback on the issues on [GitHub](#)

A network visualization on a dark blue background. A central node is highlighted in bright orange. From this central node, numerous lines radiate outwards, connecting to other nodes. The lines are color-coded, transitioning from orange near the center to green and then to light blue as they extend further. The overall structure is symmetrical and resembles a starburst or a complex network graph.

Thank you



interoperable europe

innovation ∞ govtech ∞ community

Stay in
touch



(@InteroperableEU) /



Twitter
Interoperable Europe - YouTube



Interoperable Europe | LinkedIn



DIGIT-INTEROPERABILITY@ec.europa.eu



<https://joinup.ec.europa.eu/collection/interoperable-europe/interoperable-europe>